

AHSANULLAH UNIVERSITY OF SCIENCE AND TECHNOLOGY

DEPARTMENT OF MECHANICAL ENGINEERING

ME 3102: Mechanics of Machinery Sessional

Experiment No. 02

OBJECTIVE

- To become familiar with epicyclic gearing systems and gear selection.
- To be able to determine velocity ratios of epicyclic gear systems experimentally and analytically.
- To determine torque and power transmission.

Epicyclic gearing or **planetary gearing** is a gear system consisting of one or more outer gears, or *planet* gears, revolving about a central, or *sun* gear. Typically, the planet gears are mounted on

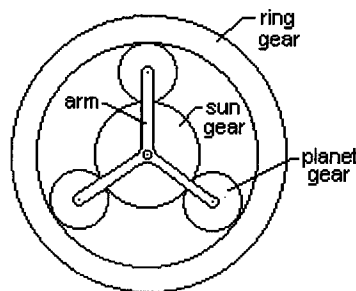

a movable arm which itself may rotate relative to the sun gear. Epicyclic gearing systems also incorporate the use of an outer ring gear or *annulus*, which meshes with the planet gears. Epicyclic gears are typically classified as simple and compound epicyclic gears. Simple epicyclic gears have one sun, one ring, one carrier, and one planet set.

Experimental Setup:

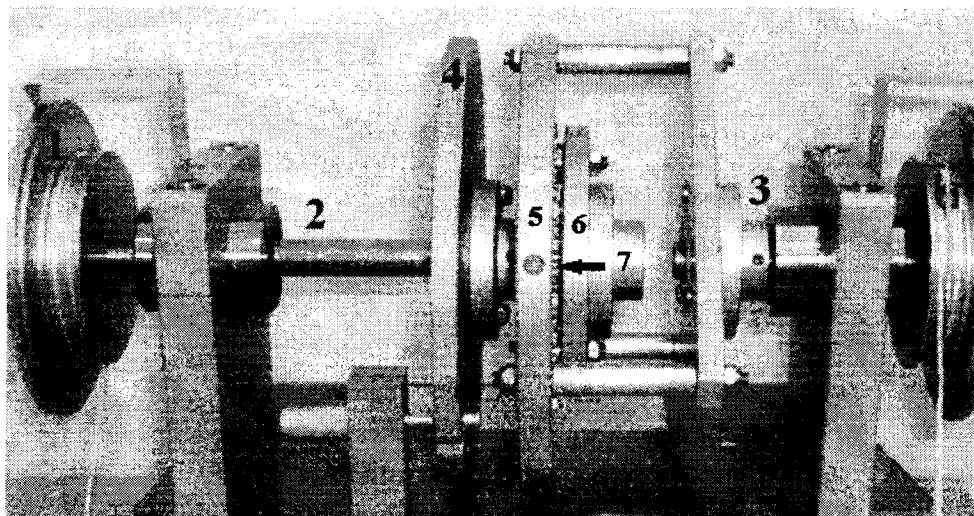

- 1) Graduated disc
- 2) Input shaft
- 3) Output shaft
- 4) Disc D
- 5) Ring
- 6) Sun gear
- 7) Planet gears (3 Units)

Power reaches the epicyclic gear through the central sun gear, that is to say, the input shaft is joined to the central sun pinion and the output power is obtained at the output shaft which is joined to the ring gear.

The shafts of the unit are made of stainless steel and the discs are made of aluminium. All the pinions are made of aluminium and mounted on ball bearings. It will allow low inertia and a reduction of losses due to friction making the practical execution easy.

Gear selection and determining velocity ratio:

Sun and Annulus Gears fixed together (Direct drive)

To calculate velocity ratio for direct drive the clutch (disc D) must be coupled to the ring of the epicyclic gear unit through a pin. As it can be observed the planetary gearing rotates as a whole.

Sun Gear Fixed (Overdrive)

To calculate velocity ratio of overdrive a pin is introduced in the disc D groove, which will simulate the braking of the central sun gear with a band brake, With the carrier arm being the input shaft and the annulus gear the output shaft, experimentally determine the velocity ratio between the input and output shafts.

Velocity ratio for different arrangement:

Gear arrangement	Direct drive		Overdrive	
	Experimental	Analytical	Experimental	Analytical
Velocity Ratio				

Discussion:

- Briefly explain how the epicyclic gear system works and its use in practical life.
- Explain what you understand by direct drive and overdrive.
- Explain the torque and power curve obtained.

Ahsanullah University of Science and Technology

Department of MPE

ME 3102: Mechanics of Machinery Sessional

Experiment 02: Study of a Manual Transmission and a Differential

GEARS

A gear is a rotating machine part having cut teeth, which mesh with another toothed part to transmit torque. For meshing the module of the gears must be same. Module is defined as,

$$m = D/N$$

Where D is the pitch circle diameter and N is the number of teeth.

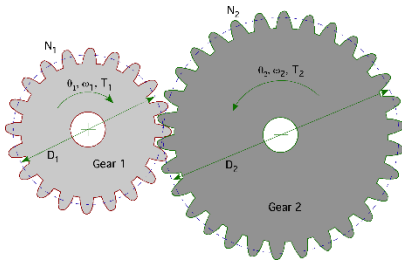

Fig1: Two external gears in mesh.



Fig2: Internal ring gear meshed with a planet gear.

Gears transmit power and provides *mechanical advantage*. [Mechanical advantage is a measure of the force amplification achieved by using a tool]

GEAR TYPES



Spur Gear



Bevel Gear



Helical Gear



Double Helical Gears or Herringbone Gears

Fig3: Different Gear types

MANUAL TRANSMISSION

Power from the engine goes to wheels via manual transmission, drive shaft, differential to wheel in a front (mounted) engine rear wheel drive, FR. Clutch connects the transmission to engine.

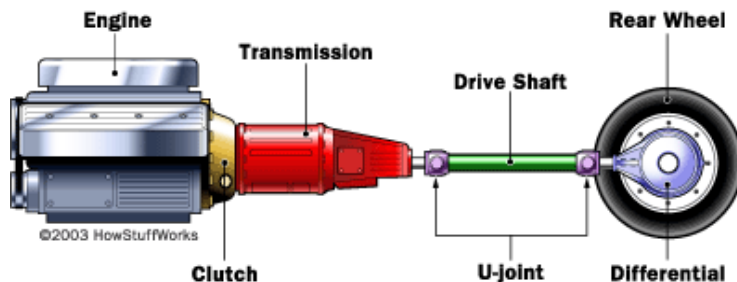

Fig4: Transmission of power in an automobile.

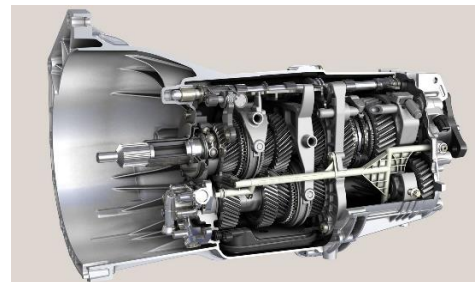

Fig5: ZF 6-speed manual transmission

SIMPLE GEAR BOX OPERATION

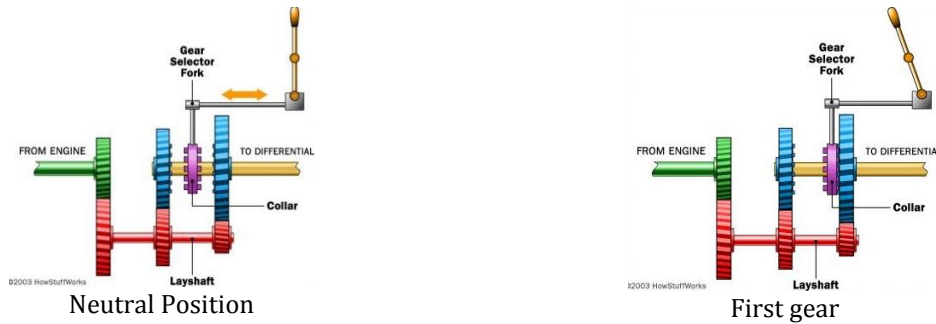

Fig 6: Simple gear box



Fig 7: A six speed gearbox handle mark

DIFFERENTIAL

The differential is a device that splits the engine torque two ways, allowing each output to spin at a different speed.

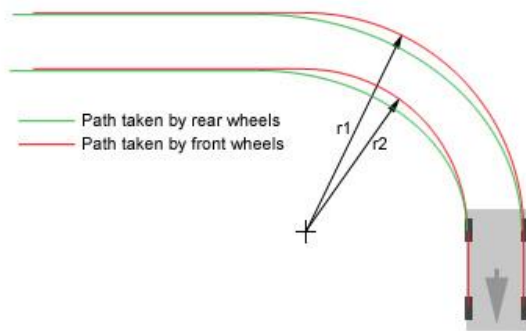

Fig 8: Path taken by two wheels is different while turning

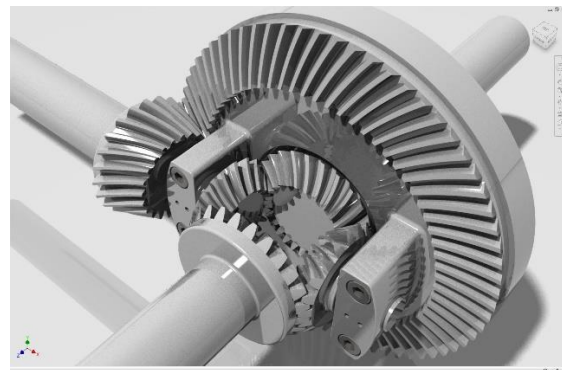

Fig 9: CAD view of an open type differential

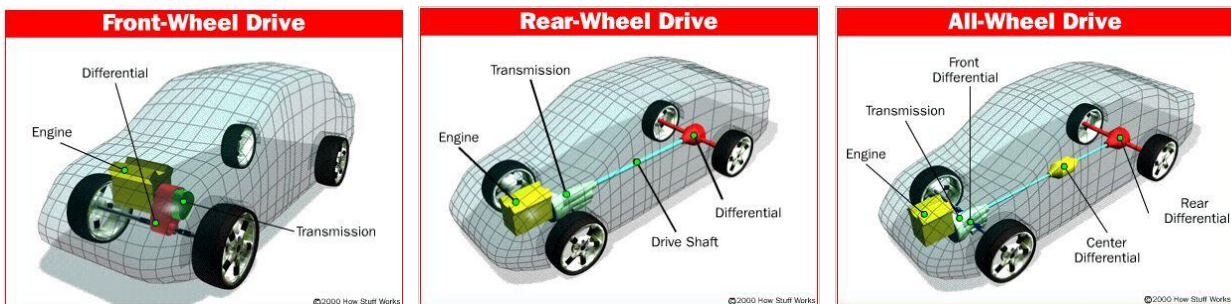

Fig 10: Differential in Automobiles

LAMBORGHINI GALLARDO



550 hp @ 1000 rpm
 0-60mph in 3.9s
 Top speed 200mph
 Rim Dia 19in

405kw @ 1000rpm
 0-100kmh in 3.9s
 Top speed 320kmh
 Rim Dia 0.4826m

Now, per rev of rim the
 path traveled,
 $Distance = \pi D$
 Distance= 1.51m

Now while accelerating,
 the required rpm for
 100kmh is,
 $V=28\text{m/s}$
 $\omega = 18.54 \text{ rps}$
 $\omega = 1112.58 \text{ rpm}$

At top speed,
 $V=90\text{m/s}$
 $\omega = 3600 \text{ rpm}$

Engine provides,
 $P = \tau \omega$
 $\tau = F \times d$
 For accelerating we
 need F
 For speed we need ω

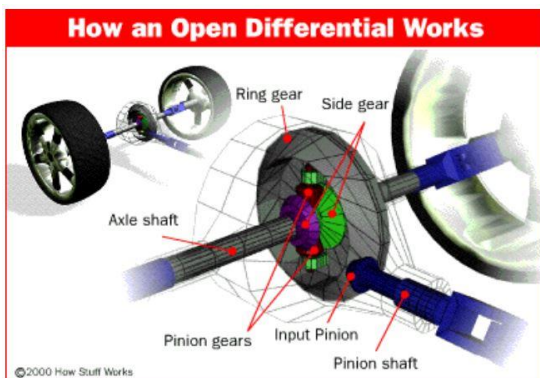

QUESTIONS

1. How many gears used in the Manual transmission and the differential? Name them and their types.
2. Calculate the ω for 21in rim dia.
3. What is a limited slip differential? How it differs from our open type one? Draw a neat sketch of a LSD.
4. Provide power transmission diagram for an automobile using automatic transmission.
5. Differentiate between automatic and manual transmission.

- power transmission
- mechanical advantages

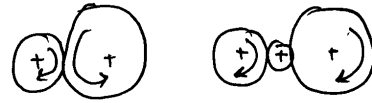

- Gears mates/ when modules are same. meshes
- Schematics:

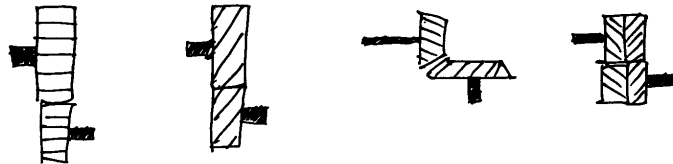

- At first Gear power division

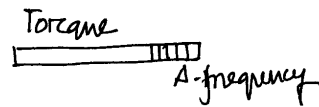

- At top Gear power division

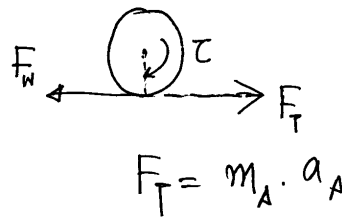
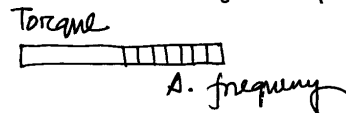

F_W = wheel's force
 F_T = traction force

M_A = mass of automobile
 a_A = acceleration of automobile

$$F_T = m_A \cdot a_A$$

So, we need, more a_A at sta starting, so more F_T is needed so more τ is needed.

- ~~manud~~ manual transmission uses "Clutch" and automatic transmission uses "Torque Converter"
- Limited Slip Differential (LSD) used for limiting the slip of wheels while on ice or hole; i.e. when no traction on a wheel.
- Gears on layshaft are pre-build on it. Gears on transmission shaft are freely rotating until meshed with collar. Collar is fixed with transmission shaft.

Ahsanullah University of Science and Technology

Department of MPE

ME 3102: Mechanics of Machinery Sessional

Experiment 05: Study of Gyroscope

Gyroscope

A gyroscope is a device for measuring or maintaining orientation, based on the principle of preserving angular momentum.

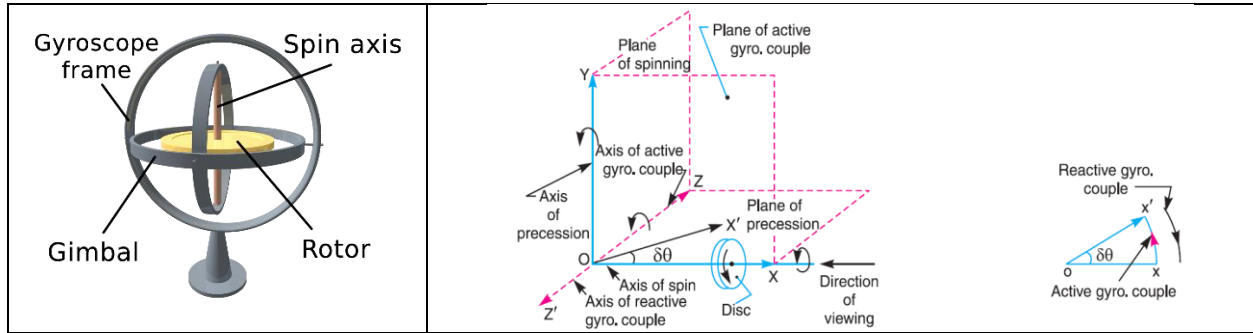

Figure: Gyroscope and gyroscopic couple.

Effect of the Gyroscopic Couple on an Aeroplane

The top and front view of an aeroplane are shown below. Let engine or propeller rotates in the clockwise direction when seen from the rear or tail end and the aeroplane takes a turn to the left.

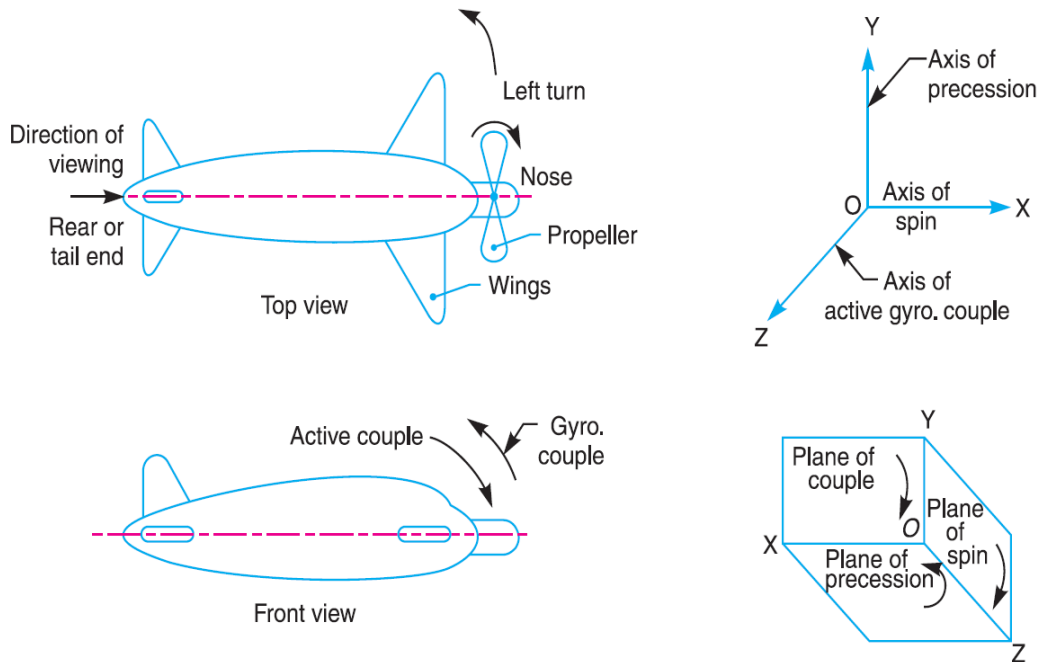

Figure: Aero plane taking a left turn.

Terms Used in a Naval Ship

The top and front views of a naval ship are shown in Fig 14.7. The fore end of the ship is called bow and the rear end is known as stern or aft. The left hand and right hand sides of the ship, when viewed from the stern are called port and star-board respectively. We shall now discuss the effect of gyroscopic couple on the naval ship in the following three cases: Steering, pitching, and rolling.

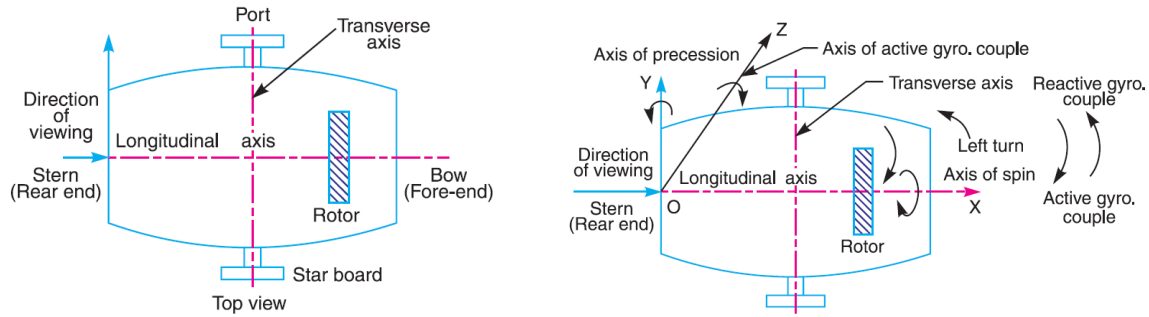

Figure: Naval ship terms; naval ship taking a Left turn.

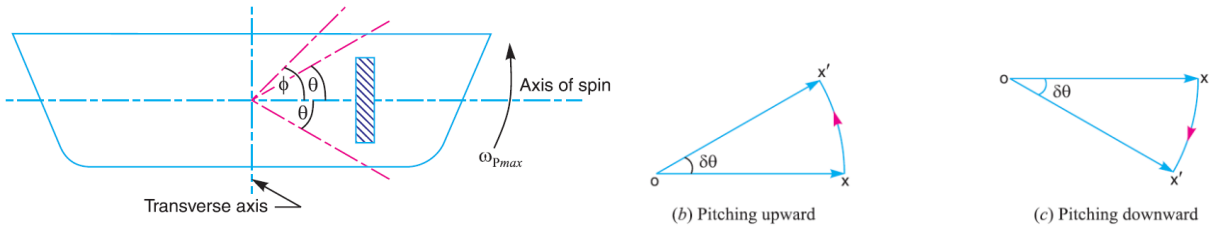

Figure: Pitching of naval ship.

Data Table

No of Obs.	Arm length (cm)	Weight (gm)	Torque (gm.cm)	Time of precession (s)	No of rev.	Precessional speed (rad/s)
1.						
2.						
3.						
4.						

Graph

Torque vs. precessional speed.

Questions

1. Why Rolling has no gyroscopic effect on naval ships?
2. How gyroscope can be helpful to maintain balance in aero plane and ships?
3. Discuss the gyroscopic effects while an Aero plane taking a right turn.
4. Discuss the gyroscopic effects while a naval ship taking a right turn.
5. Does a paper aero plane affected by gyroscopic effect? Explain.